



EWS . Varia VX

Rüstzeitreduzierung durch powRgrip[®] und das innovative EWS Varia VX Schnellwechselsystem

Reduction of set-up time through powRgrip[®] and the EWS Varia VX quick change system

Varia VX-Adapter für powRgrip®

Varia VX-Adapter for powRgrip®

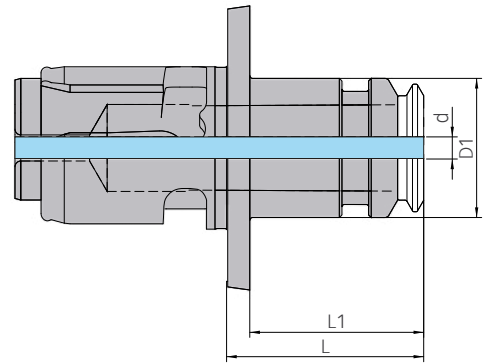

Typ/Type	Art.-Nr./Part no.	Abmessungen/Dimensions [mm]				
		D1	d min.	d max.	L	L1
powRgrip® Varia VX-Adapter						
EWS VX3 / PG 15	8350.03150 19.VX3PG15L29.5*	24	3	12.7	34	30
EWS VX4 / PG 25**	8350.04251 19.VX4PG25L39*	40	3	20	45	41











*EWS Art.-Nr./Part no.

** Nur spannbar mit PGU / Only to be used with PGU

powRgrip® Spannzangen Typ

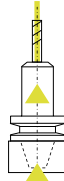
powRgrip® collets type

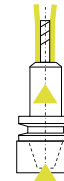
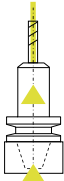

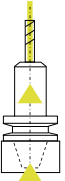
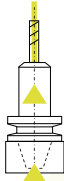
							
	Std.	CF	CB	L	S	SG	TAP
	Standard	Kühlkanal	Kühlbohrung	langer Schaft	kurzer Schaft	secuRgrip®	Gewindebohrzange
Hauptanwendung	Allgemeine Bearbeitung	Periphere Kühlmittelzufuhr	Periphere Kühlmittelzufuhr	Länger als DIN 6535	Kürzer als DIN 6535	Schwerzerspannung	Gewindebohren
PG-Grösse	15–25	15–25	15–25	15–25	10–32	15–32	15–25
Schaftdurchmesser	3–20	3–20	6–20	4–20	4–20	10–20	3,5–16
Spannbereich [mm] oder Toleranz	h6	h6	h6	h6	h6	h6	h9
Zusatzfunktionen	Länge kann voreingestellt werden	Länge kann voreingestellt werden	Länge kann voreingestellt werden	Ohne Anschlagsschraube	Länge kann voreingestellt werden	Für alle Werkzeuge mit Weldon-Fläche gemäss DIN 535-HB	Länge kann voreingestellt werden
Technische Zeichnung der Kühlung							

REGO-FIX powRgrip®

EINFACH / SIMPLE

Werkzeug per Knopfdruck in 8 Sekunden gespannt
Tool is clamped in 8 seconds by pushing one single button

SICHER / SAFE

Keine Hitzeentwicklung – Hohe Spannkraft
No heat – high clamping force

powRgrip®

Das Werkzeugspannsystem für heute und morgen
The tool clamping system of today and tomorrow



Schneidwerkzeug
Cutting tool



REGO-FIX powRgrip®-Spannzange
REGO-FIX powRgrip®-collet



Varia VX-Adapter für powRgrip®
Varia VX-adapter for powRgrip®

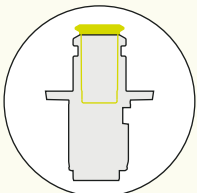

Ausgezeichneter Rundlauf bei hoher Wiederholbarkeit.

Excellent concentricity with high repeatability.

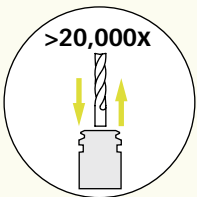

Höchste Haltekraft und Rundlaufgenauigkeit auch nach 20'000-fachem Werkzeugwechsel.

Maximum clamping force and low runout, even after 20,000 tool changes.

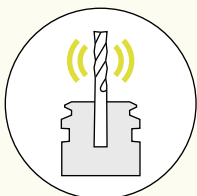

Hervorragende Vibrationsdämpfung.

Excellent vibration dampening.

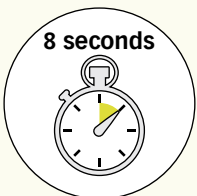

Einsatzbereite Werkzeuge in 8 Sekunden mit der PGU 9500.

Tool ready for use in 8 seconds.





036200289_RECH_LEWS_Flyer_DE_EN



ADVANCED TECHNOLOGY TOOLS

reich Tools GmbH

Bäckergasse 5, 4707 Schlüsslberg

T +43 7248 68 537 F +43 7248 64 285

E office@reich.at W www.reich.at

REGO-FIX AG

Obermattweg 60
4456 Tenniken
Switzerland
info@rego-fix.com

REGO-FIX

www.rego-fix.com